

RC枠 アングル付

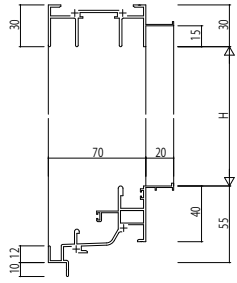

2枚建

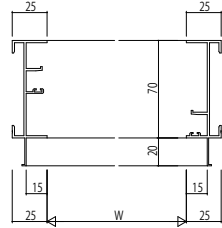

4枚建

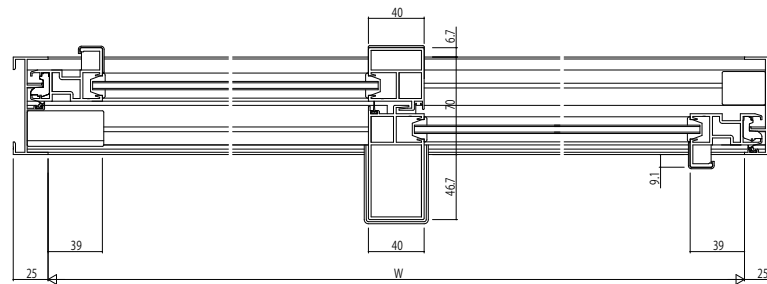
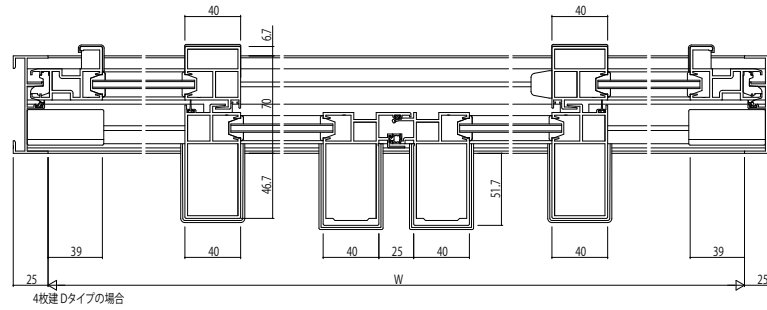
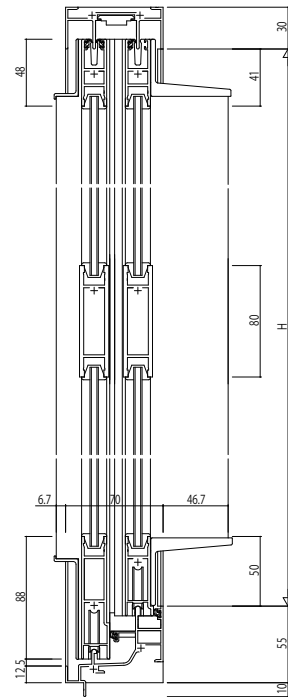
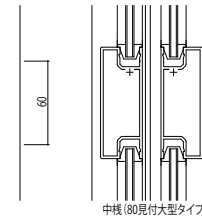
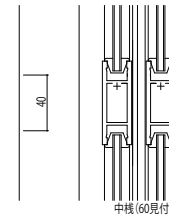
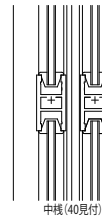
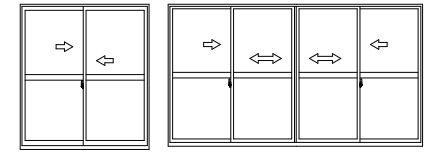
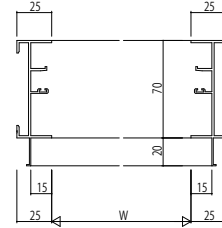

変更記事	設計監理

工事名	

照査	担当	作図	尺度	御承認印
			1/1	

図番	

