

下枠
FIX窓/FIX窓

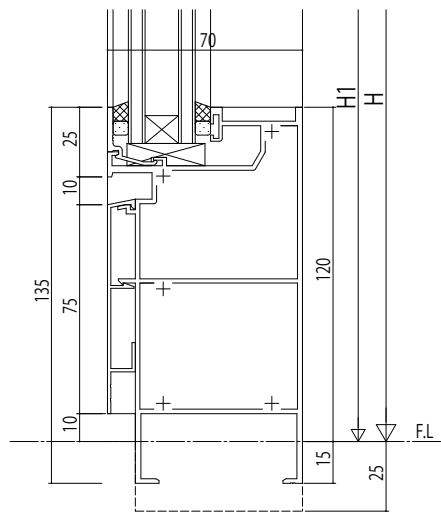

135mm見付幅木

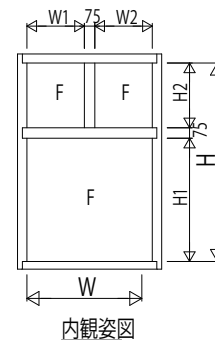

内観姿図

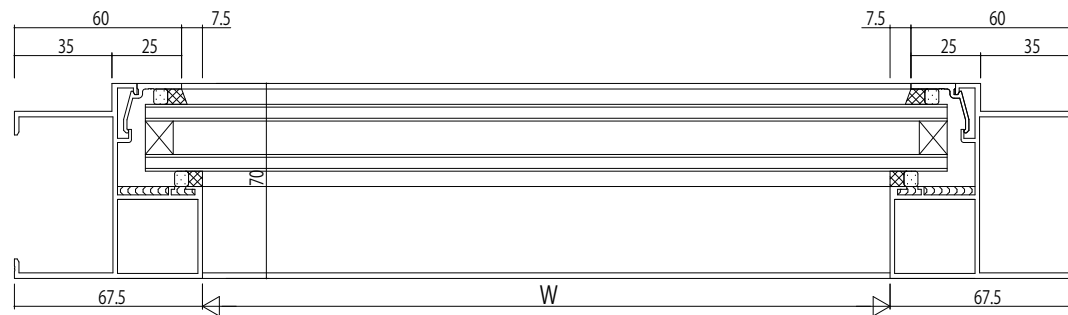
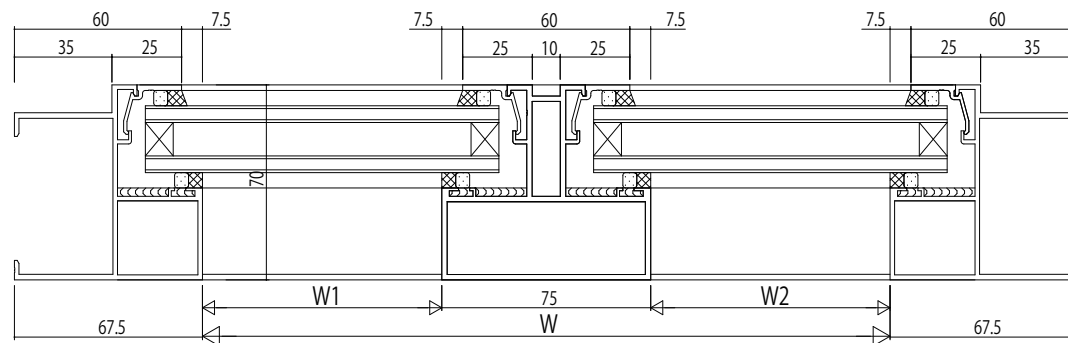

変更記事	設計監理

工事名	
図面内容	SYSTEMA31e RC枠 FIX窓 35mm溝幅 70見込

照査	担当	作図	尺度
			1/1

御承認印	年月日

図番	通し図番

