

ALC 枠 アンゲル付

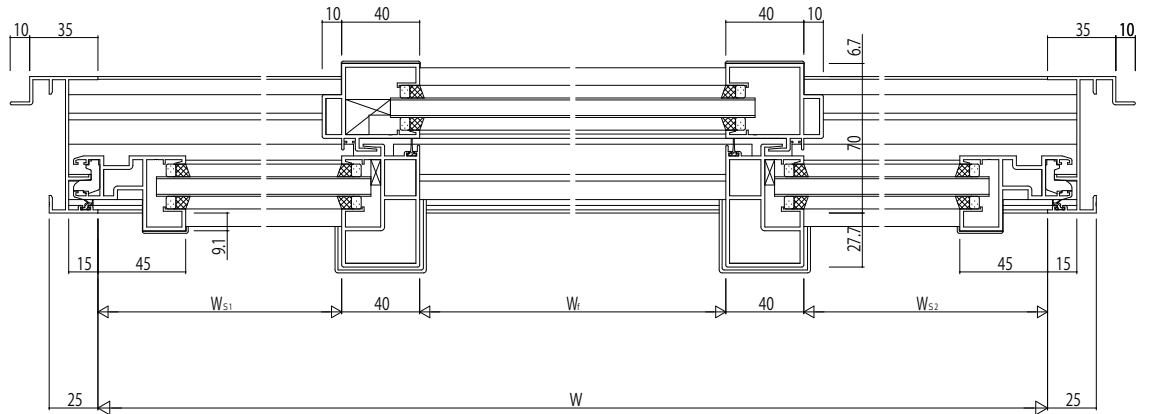
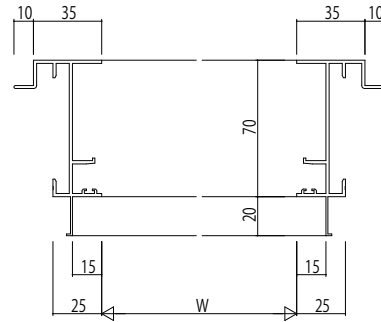
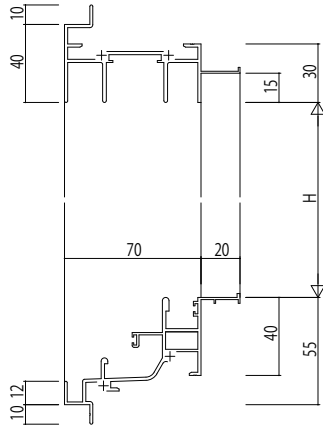

変更記事	

設計監理	
施工	

工事名	RE31S236	工事
図面内容	EXIMA 31 T-1 両袖片引き窓【内動タイプ】 ALC枠 C31 / 23mm溝幅	

照査	担当	作図	尺度
			1/1

御承認印	年月日

図番	通し図番

