

(81) FIX窓(内押縁・外押縁)/内開き窓・たて軸回転窓

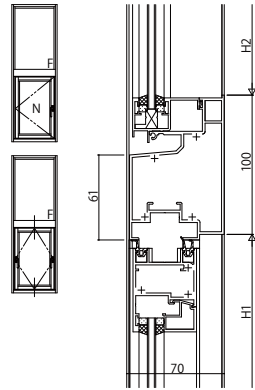

(82) 外倒し窓(一般・露出・隠べい)/内開き窓・たて軸回転窓

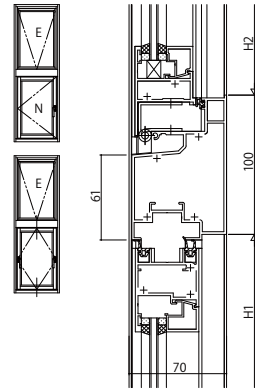

(83) 内倒し窓(一般・露出・隠べい)/内開き窓・たて軸回転窓

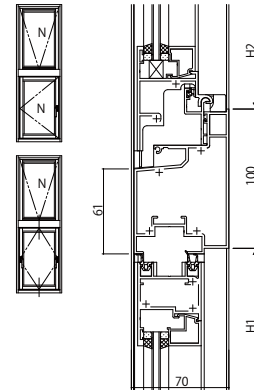

(84) 突き出し窓(カムラッチ・露出)/内開き窓・たて軸回転窓

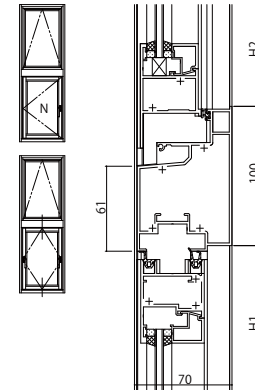

(85) 固定がらり(非脱着)/内開き窓・たて軸回転窓

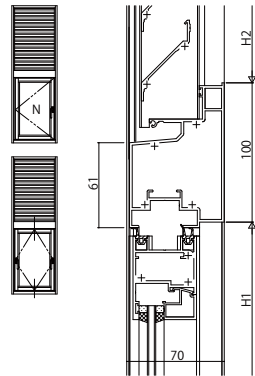

(86) 内開き窓・たて軸回転窓/固定がらり(非脱着)

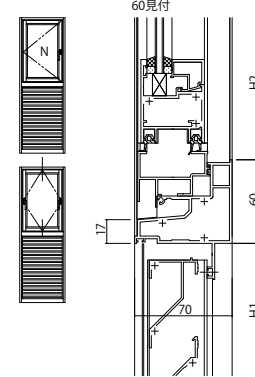

100見付

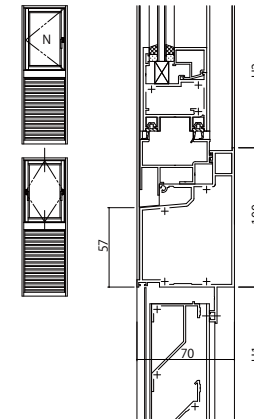

(87) 引違い窓(3枚建)/引違い窓(3枚建)

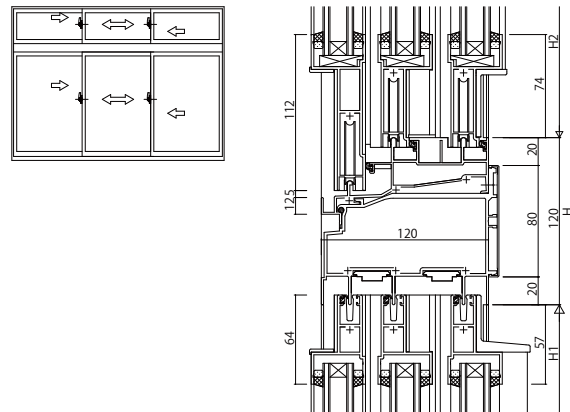

(88) 引違い窓(4枚建)・両袖片引き窓/引違い窓(4枚建)・両袖片引き窓

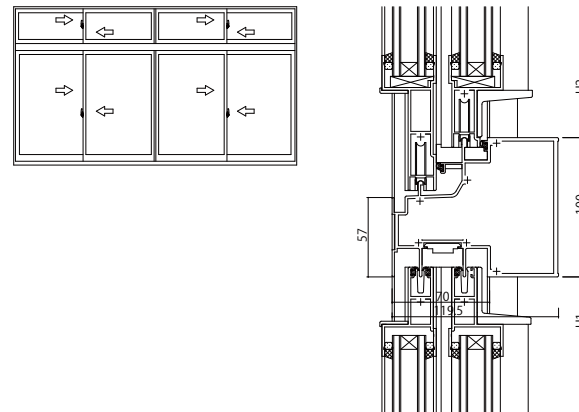

変更記事	設計監理

工事名	
図面内容	EXIMA31 段窓無目(81)~(88)

照査	担当	作図	尺度
			1/1

御承認印	
年月日	

図番	
通し図番	

