

BHn ≥ 998の場合
網戸上下框

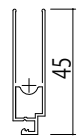

BHn > 1322, BWn ≤ 1860の場合
上框

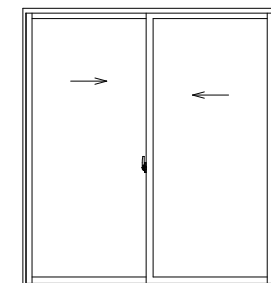
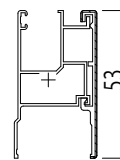

内観姿図

BHn > 1322, BWn ≤ 1860の場合
下框

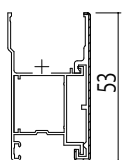

BHn > 1322, BWn ≤ 1860の場合
戸先框

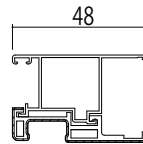

BHn > 1122, BWn ≤ 1860の場合
内召合框

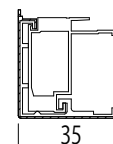

(15.4) 23.3

網戸出来幅 MW 45 45 16.8 (15.4)

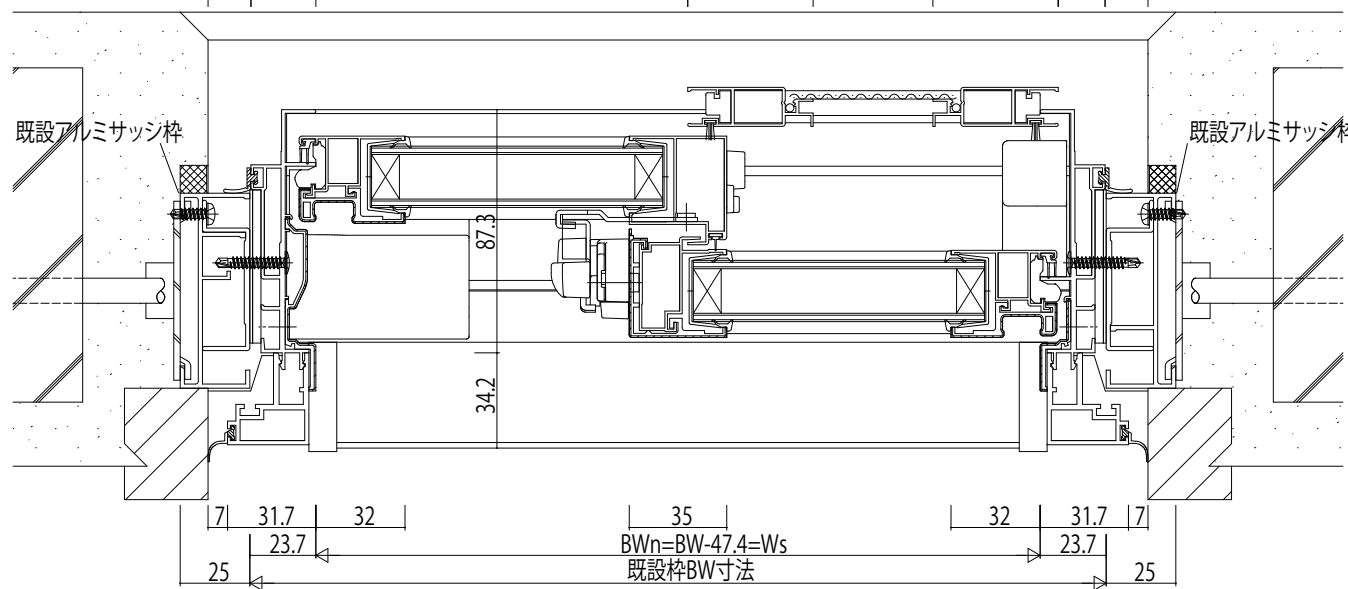

変更記事	設計監理

工事名	照査	担当	作図	尺度	御承認印	図番
既設枠70見込 窓タイプ 26mm溝幅				1/1		年月日

