

●ふかし枠(40mm)

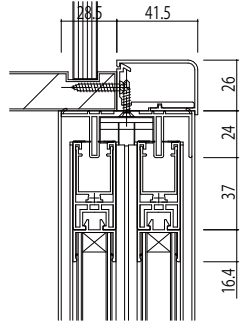

●ふかし枠(70mm)

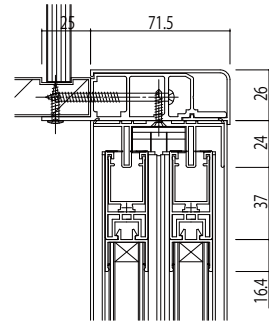

●ふかし枠(40mm)

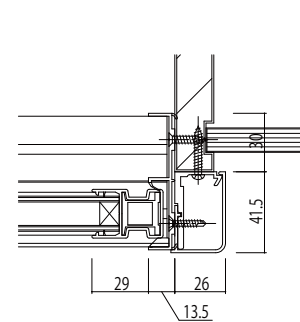

●ふかし枠(70mm)

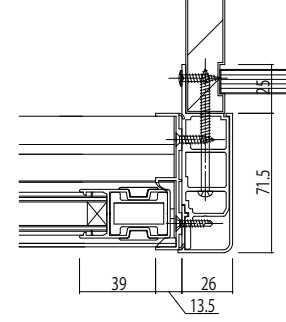

●ふかし枠(40mm)

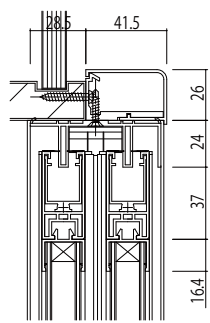

●ふかし枠(70mm)

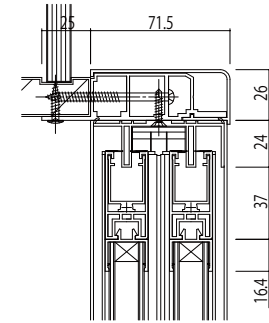

●ふかし枠(40mm)

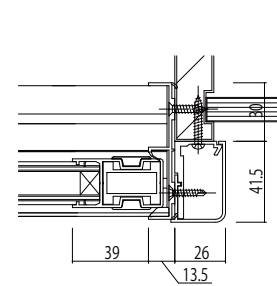

●ふかし枠(70mm)

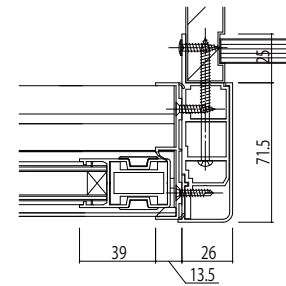

●カーテンレール対応ふかし枠25取付時

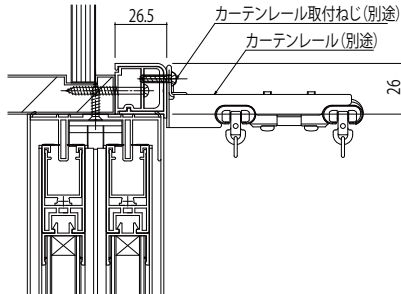

●カーテンレール対応ふかし枠40取付時

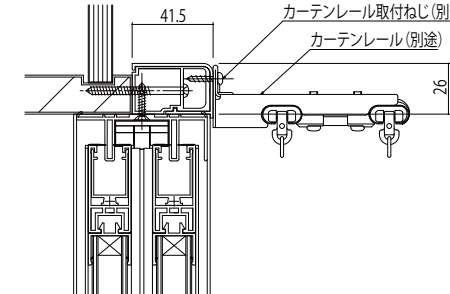

●カーテンレール対応ふかし枠70取付時

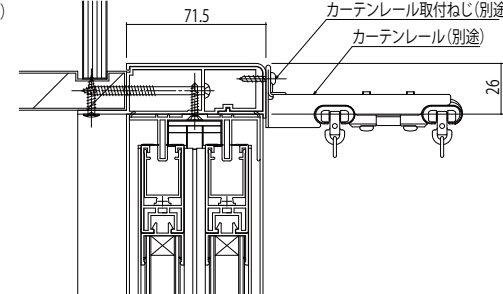

変更記事	設計監理

工事名	
図面内容	ブレードUふかし枠 カーテンレール対応ふかし枠(オプション)

照査	
担当	
作図	
尺度	1/1

御承認印	
年月日	

図番	
通し図番	

