

●30mm溝幅

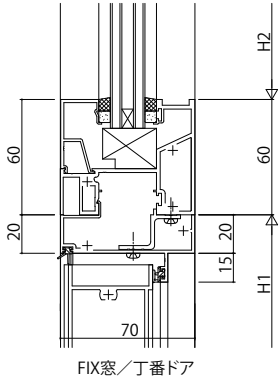

FIX窓/丁番ドア

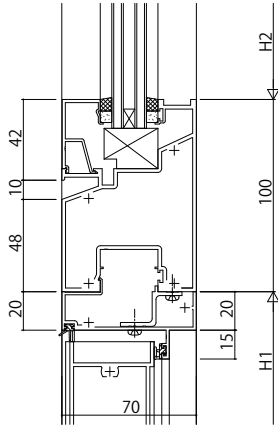

FIX窓/丁番ドア

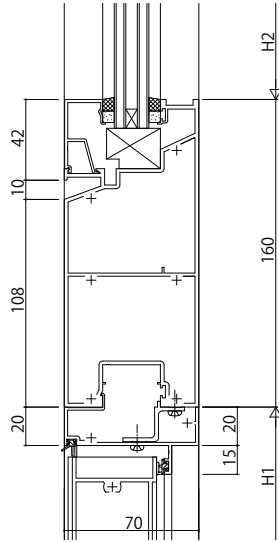

FIX窓/丁番ドア

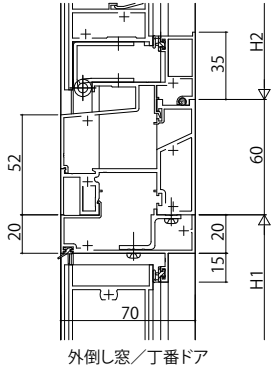

外開し窓/丁番ドア

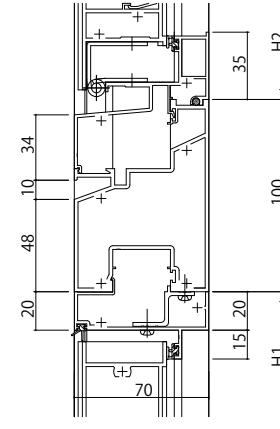

外開し窓/丁番ドア

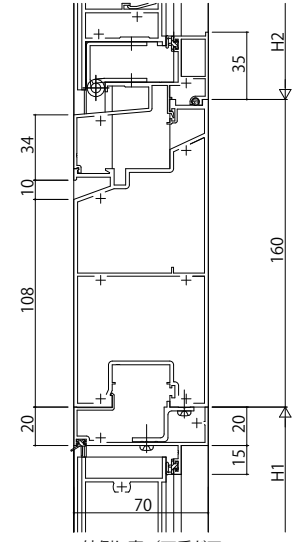

外開し窓/丁番ドア

●下枠

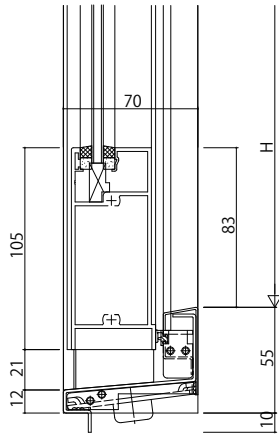
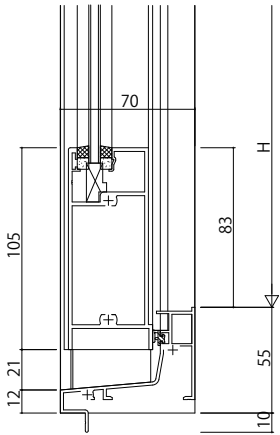

ステンレス下枠

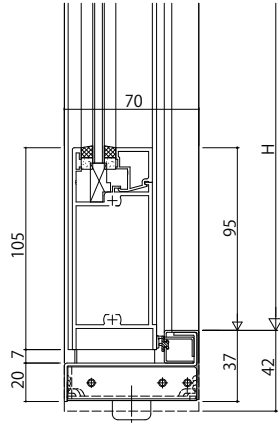

フラット下枠(37見付)

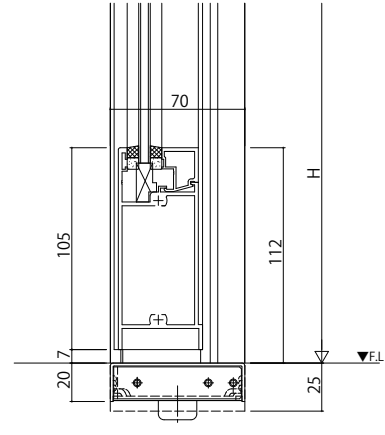

ステンレス下枠(フラット下枠)

変更記事	

設計監理	殿
施工	殿

工事名	EXIMA 31e片開きドア/両開きドア【丁番ドア】 無目30mm溝幅下枠
-----	--

照査	担当	作図	尺度
			1/1

御承認印	年月日

図番	通し図番

