

ランマなしの場合

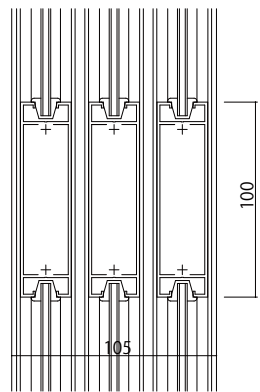

中棧

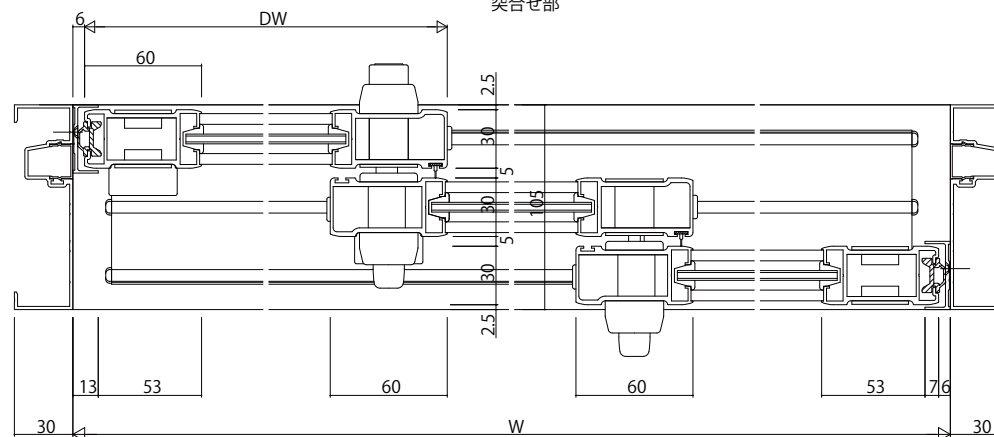
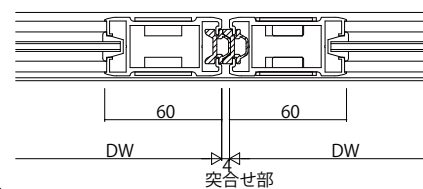
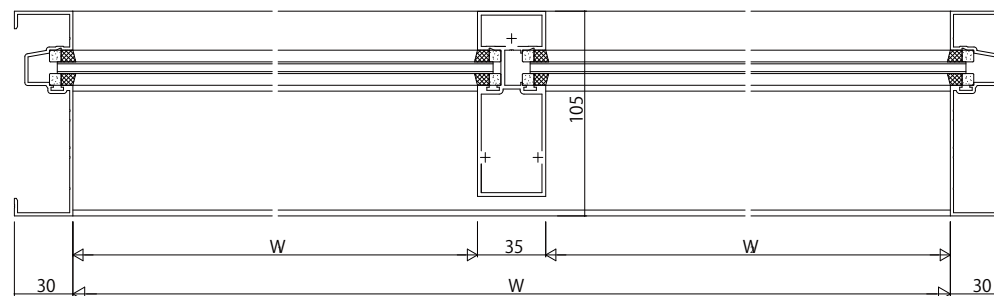
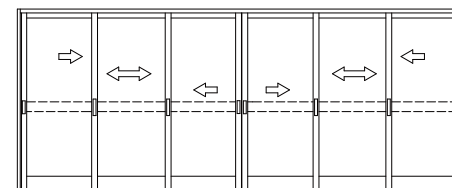
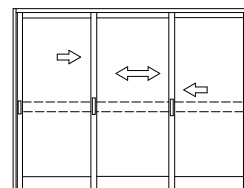
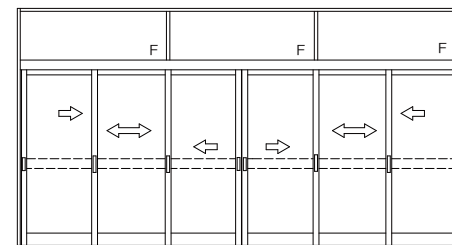
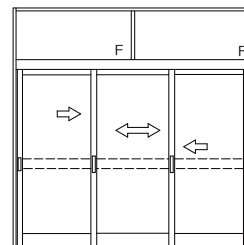

変更記事	設計監理
	施工

工事名	照査	担当	作図	尺度	御承認印
EXIMA 51e RC枠引違い戸【かまちタイプ】				1/1	
枠内3-6枚建てかまち60mm見付 障子:11mm溝幅 枠:18mm溝幅					

図面内容	年月日	通し図番

