

RC 枠 アンガル付

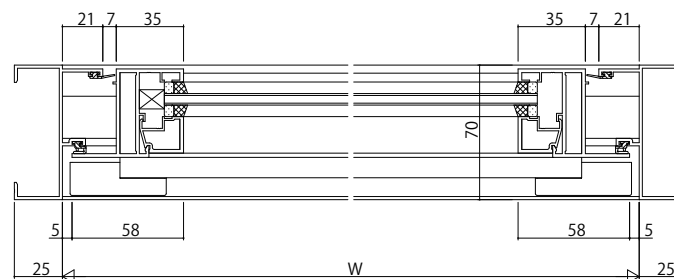

変更記事	設計監理	殿 殿	工事名	工事	照査	担当	作図	尺度	御承認印	図番
	施工		図面内容		EXIMA 31 内倒し窓【2段階オープン仕様】 RC枠 18mm溝幅	1/1	年月日	通し図番		

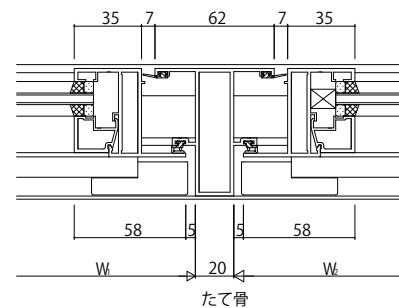
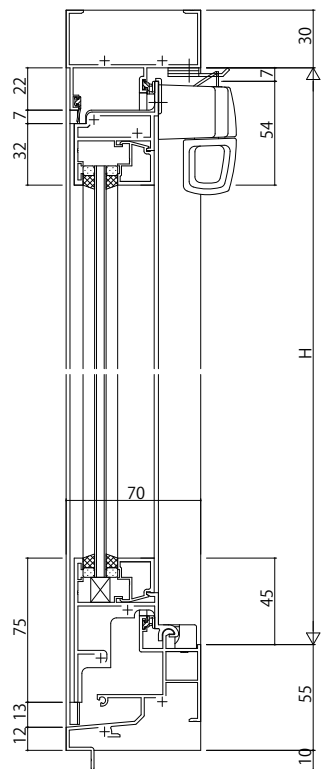
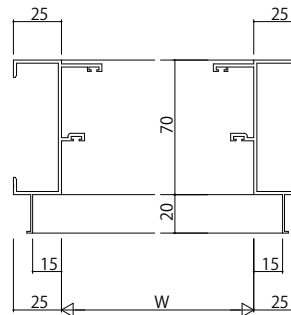
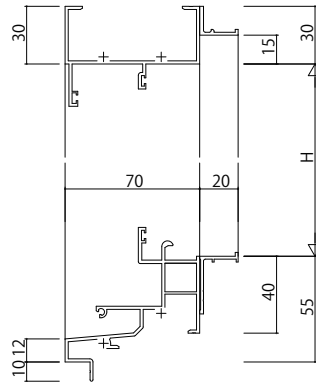