

RC枠 アンゲル付

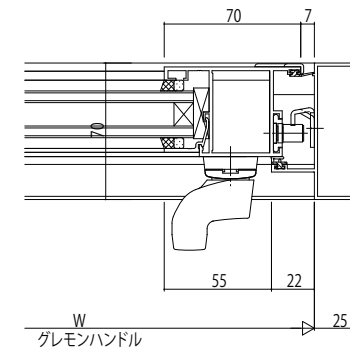
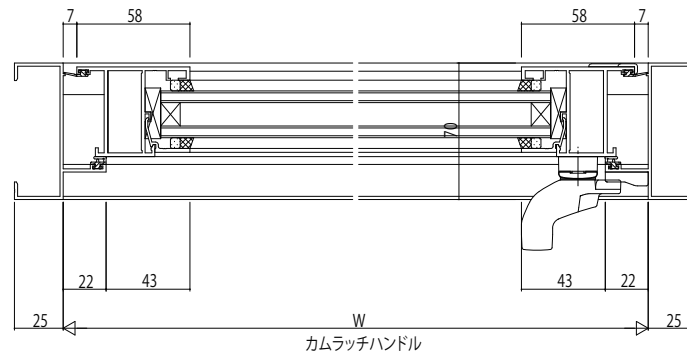
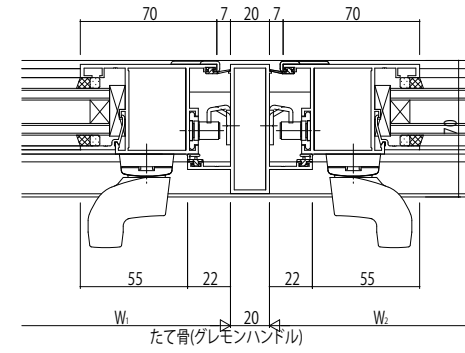
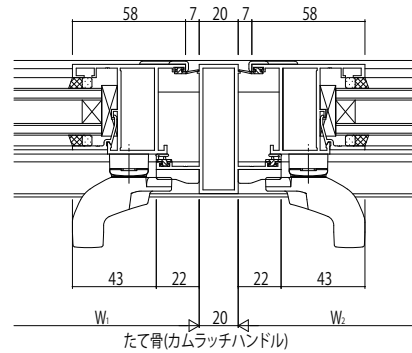
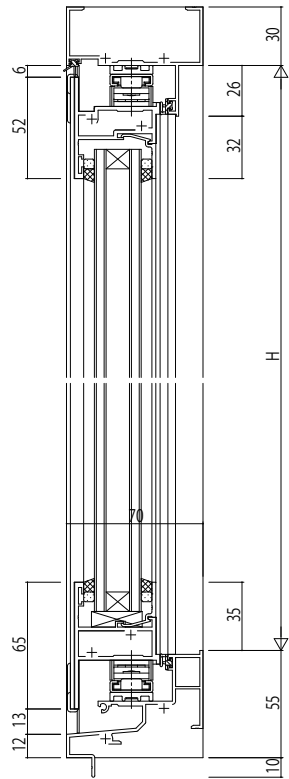
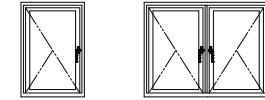
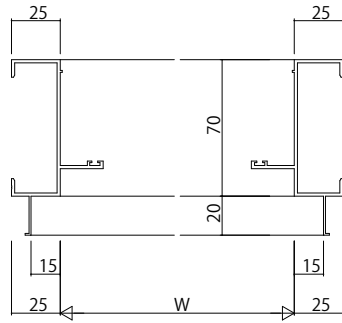
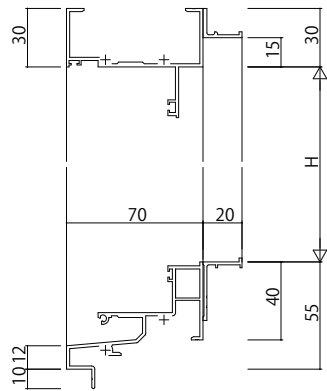

変更記事	設計監理

工事名	RE31P044	工事
図面内容	EXIMA 31 たてすべり出し窓 RC枠 カムラッチ・グレモン/35mm溝幅	

照査	担当	作図	尺度	御承認印
			1/1	

	年月日

図番	
通し図番	

