

RC枠 アンゲル付

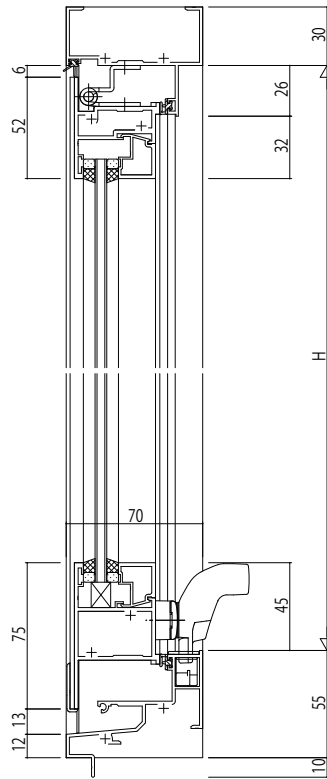

カムラッチハンドル

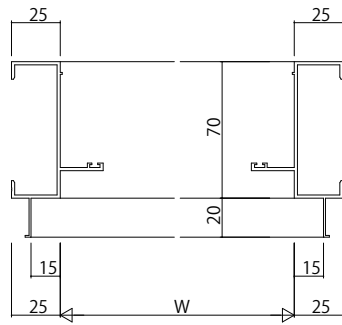
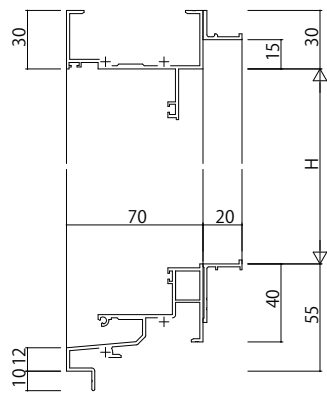
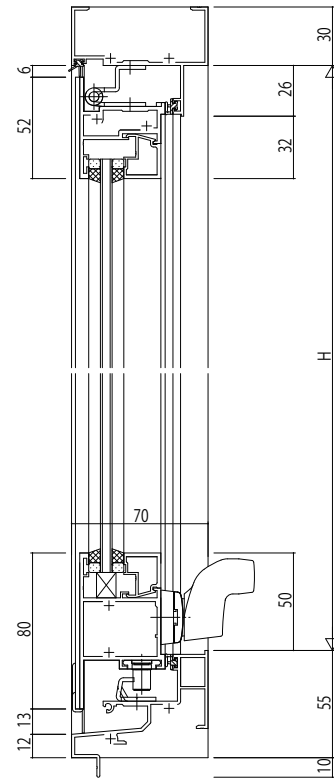

グレモンハンドル

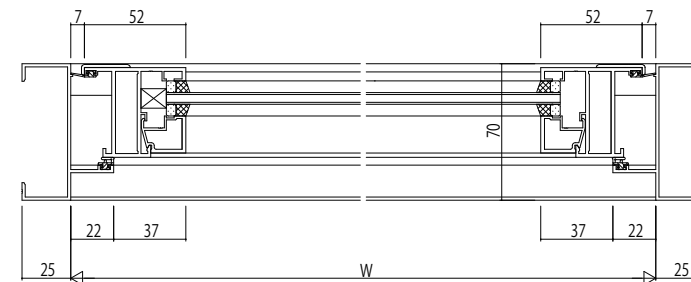
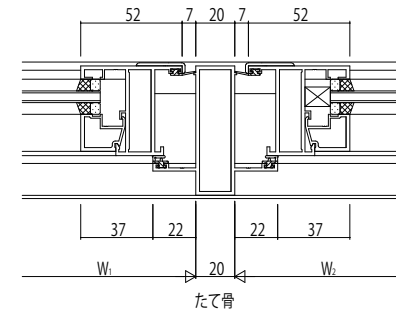
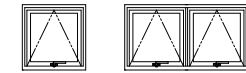

変更記事	

設計監理	
施工	

工事名	RE31P129	工事
図面内容	EXIMA 31 突出し窓 RC枠 カムラッチ・グレモン/18mm溝幅	

照査	担当	作図	尺度	御承認印
			1/1	

図番	年月日	通し図番

