

RC 枠 アングル付 2枚建

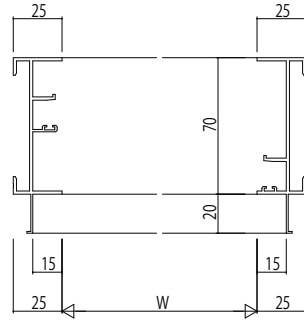

RC 枠 アングル付 4枚建

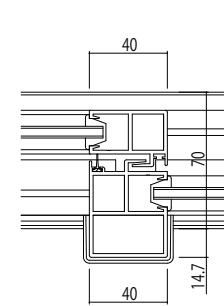
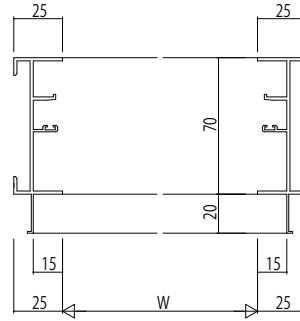

4枚建 Bタイプ召合せかまちの場合

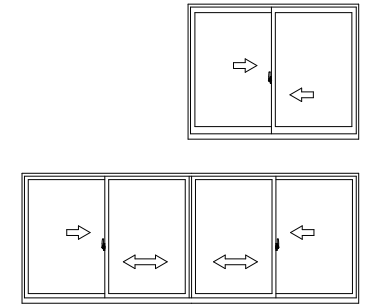

RC 枠 アングル付

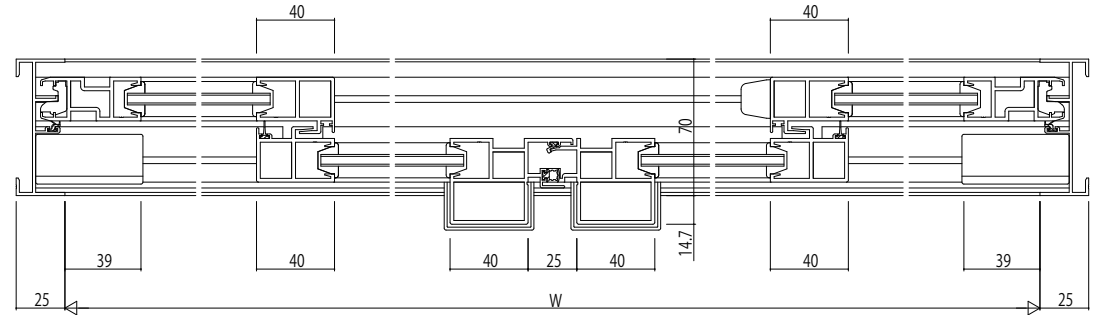
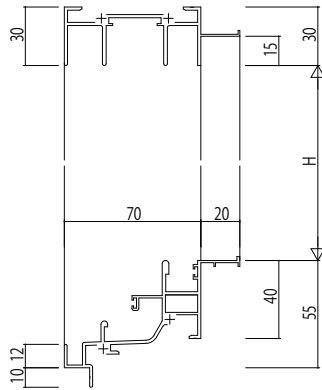
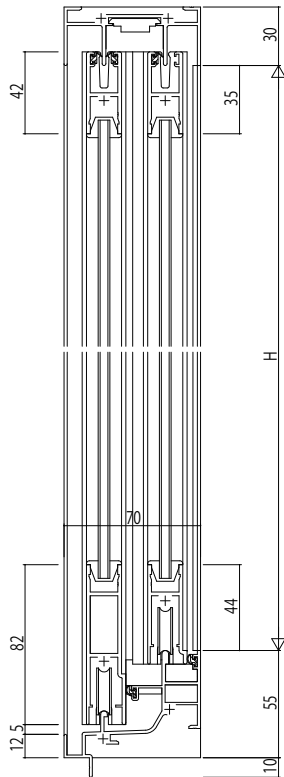

4枚建 Aタイプの場合

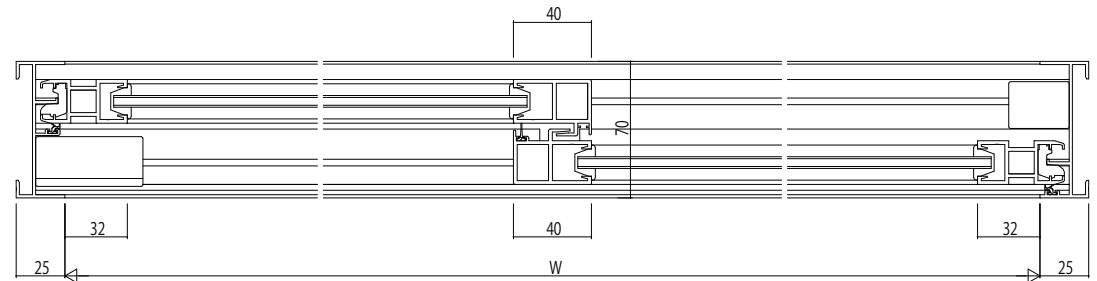

変更記事	設計監理

工事名	

照査	

担当	

作図	

尺度	1/1

御承認印	

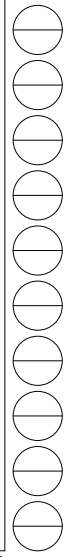

図番	

