

RC枠 アングル付

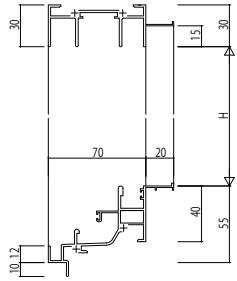

2枚建

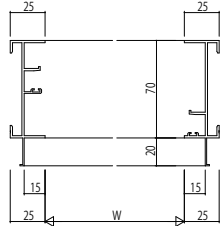

4枚建

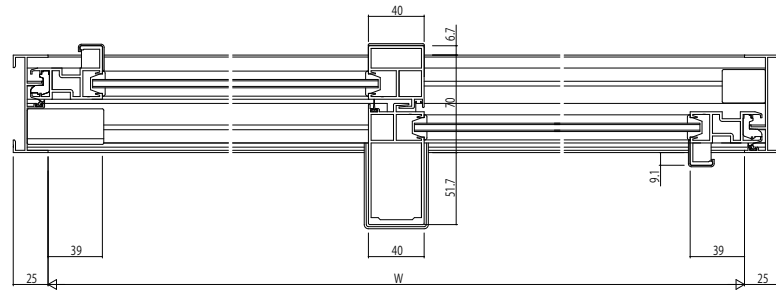
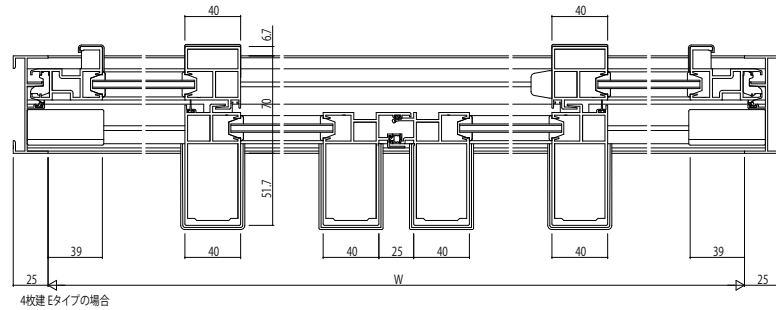
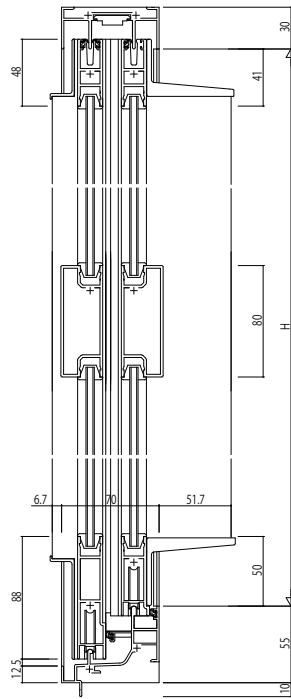
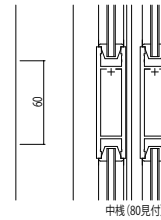
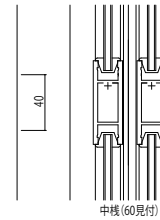
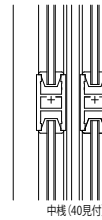
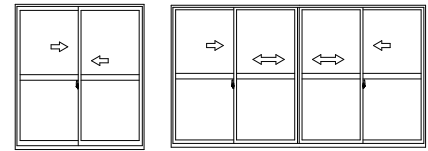
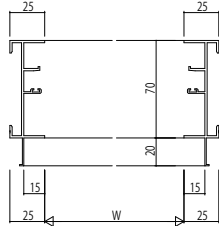

変更記事	設計監理

工事名	

照査	担当	作図	尺度
			1/1

御承認印	

図番	

