

中棧(60見付)

RC枠 アングル付2枚建

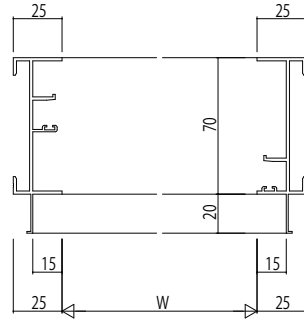

RC枠 アングル付4枚建

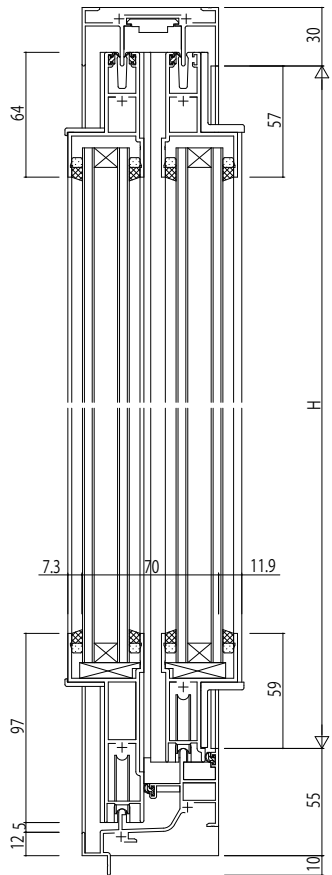
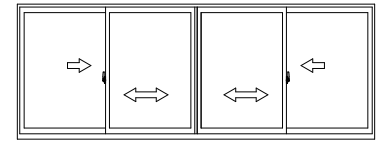
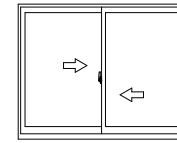
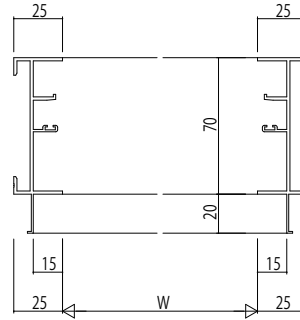

RC枠 アングル付

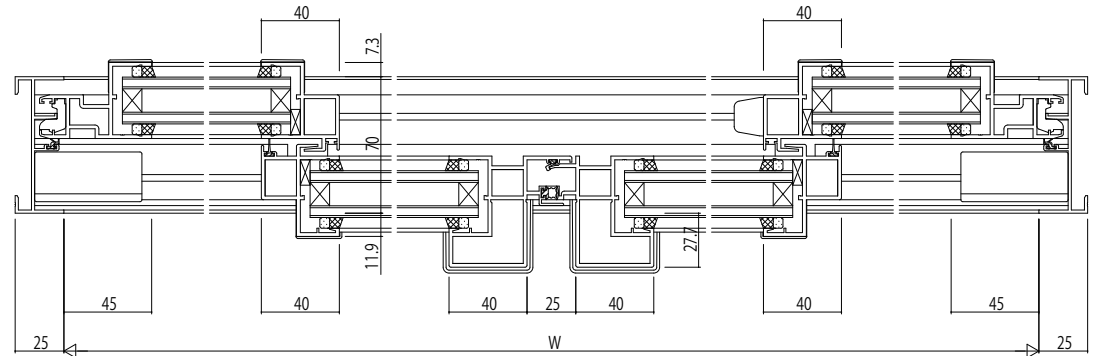
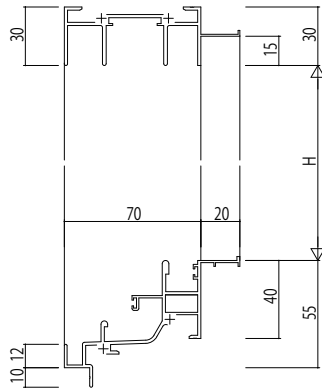

4枚建 Aタイプの場合

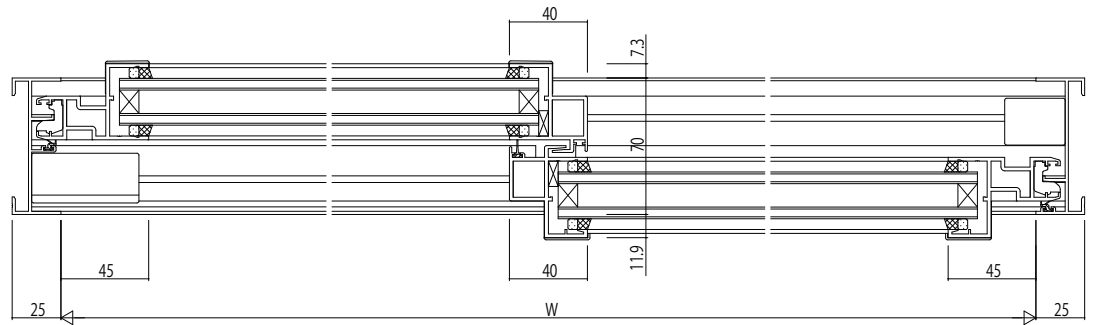

変更記事	設計監理

工事名	
図面内容	EXIMA 31 T-1 引違い窓(2・4枚建) RC枠 Aタイプ /35mm溝幅

照査	
担当	
作図	
尺度	1/1

御承認印	
年月日	

図番	
通し図番	

