

## ■引違い窓 Cタイプ・窓タイプ 在来木造納まり 単板ガラス

内観姿図

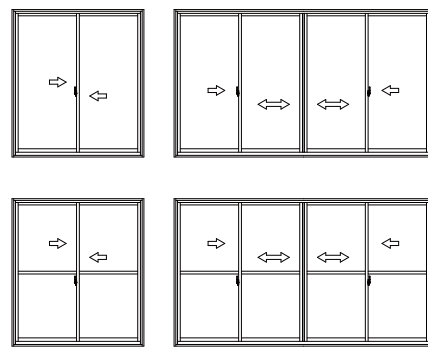

### ●中棧

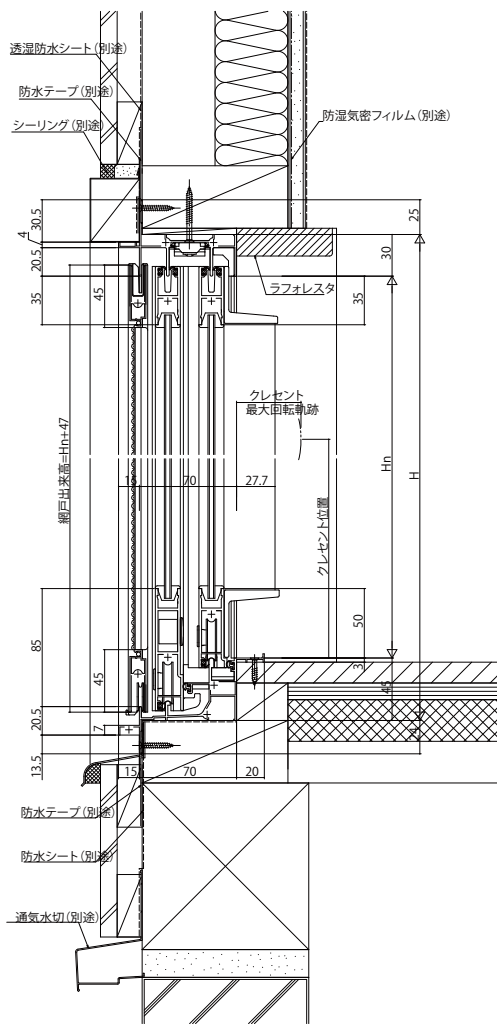
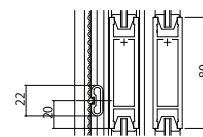
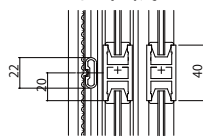

### ●窓タイプ

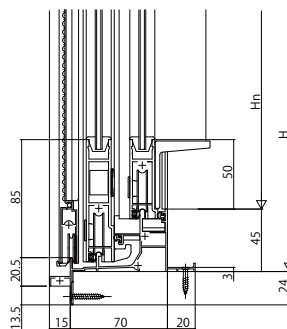

### ●リビングタイプ

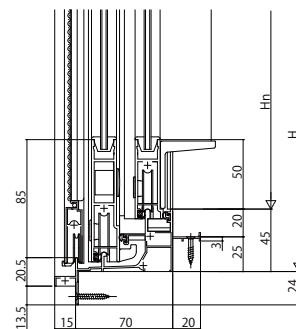

### ●4枚建突合せ部

網戸出来幅 $MW=Wn/4+24$  網戸出来幅 $MW=Wn/4+24$

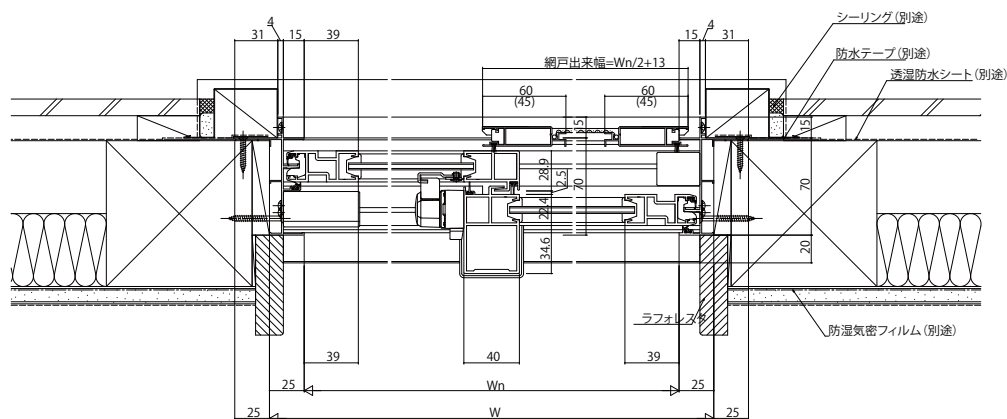
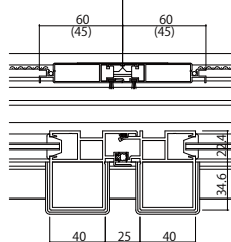

※網戸( )寸法は $1400 < Hn \leq 1500$ を示す