

## ■断面図 Dタイプ

複層ガラス

内観姿図

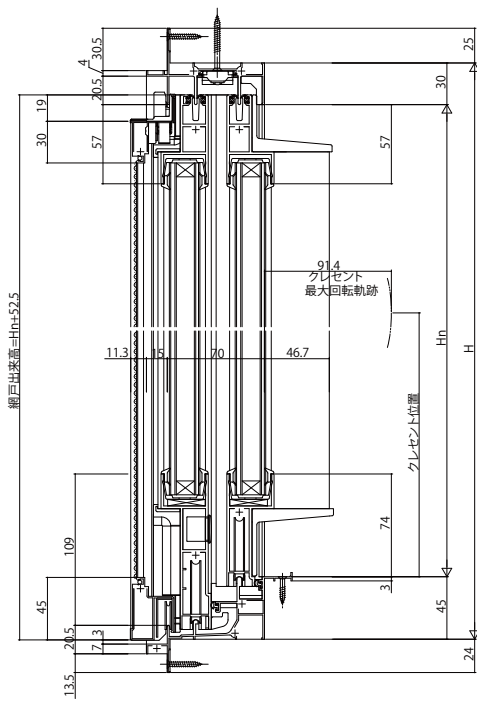
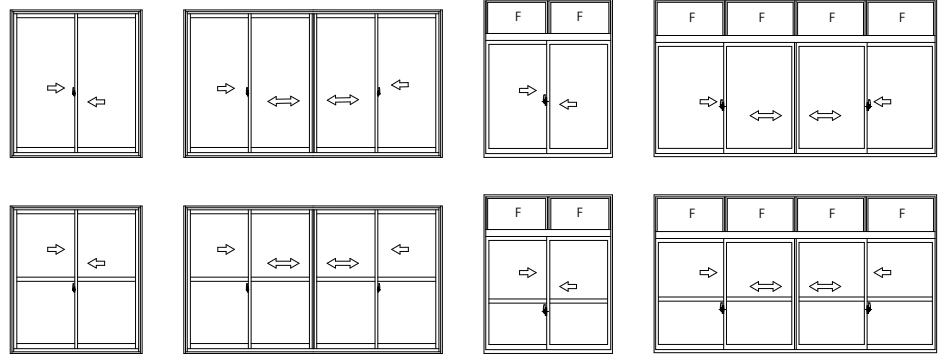

### ●中棧

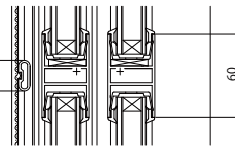

### ●段窓ランマFIX部

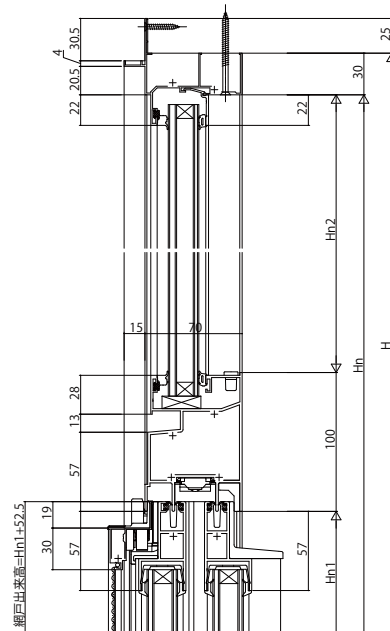

### ●9尺用無目

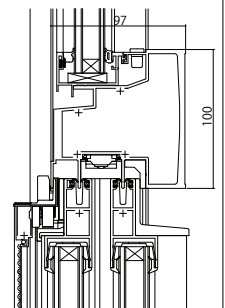

### ●4枚建突合せ部

網戸出来幅=Wn/4+9 網戸出来幅=Wn/4+9

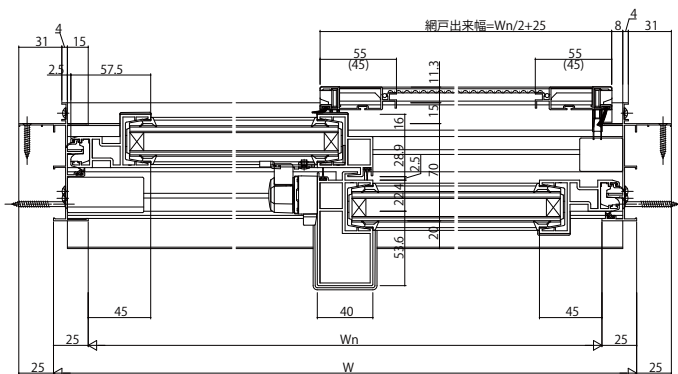
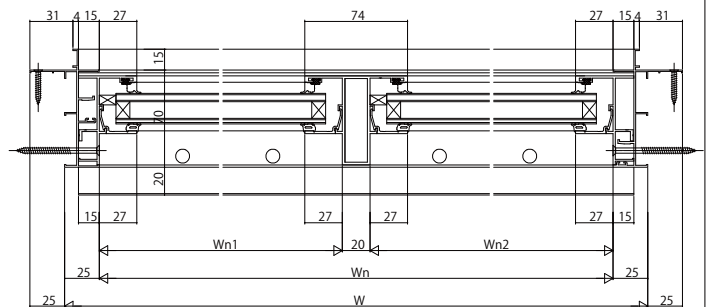
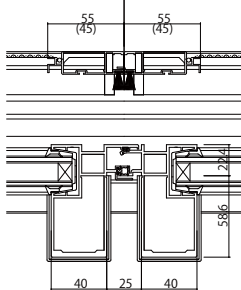

※網戸( )寸法はHn≤2000を示す