

エクスタラップII

■エクスタラップII

■側面図

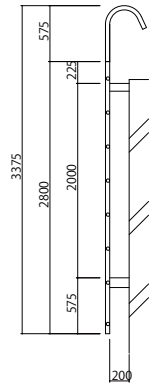

単体タイプA

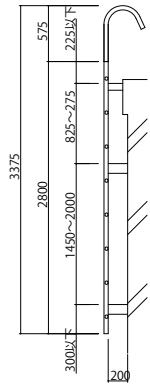

単体タイプB

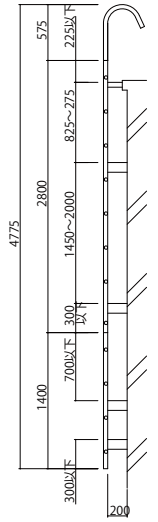

連結タイプ

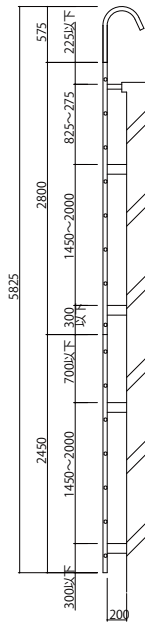

連結タイプ

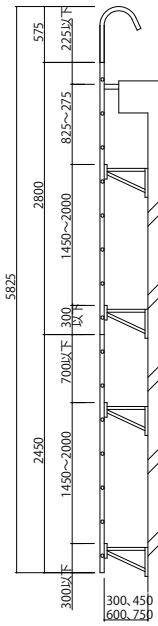

連結タイプ

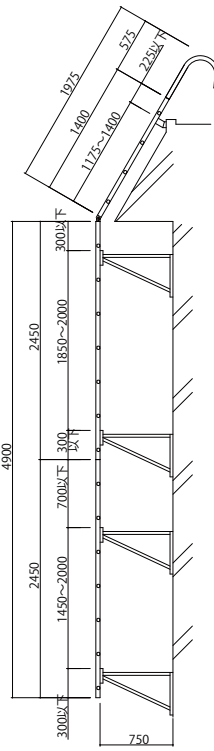

連結角度自在タイプ

■ブラケット用水切(オプション)

■正面図

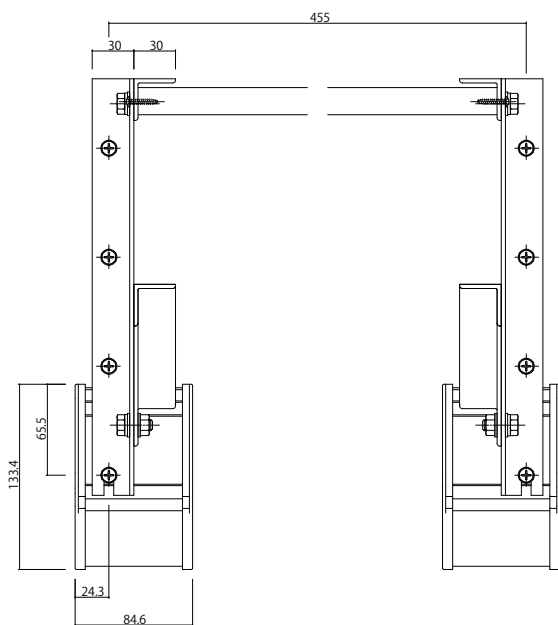

A部正面詳細

■側面図

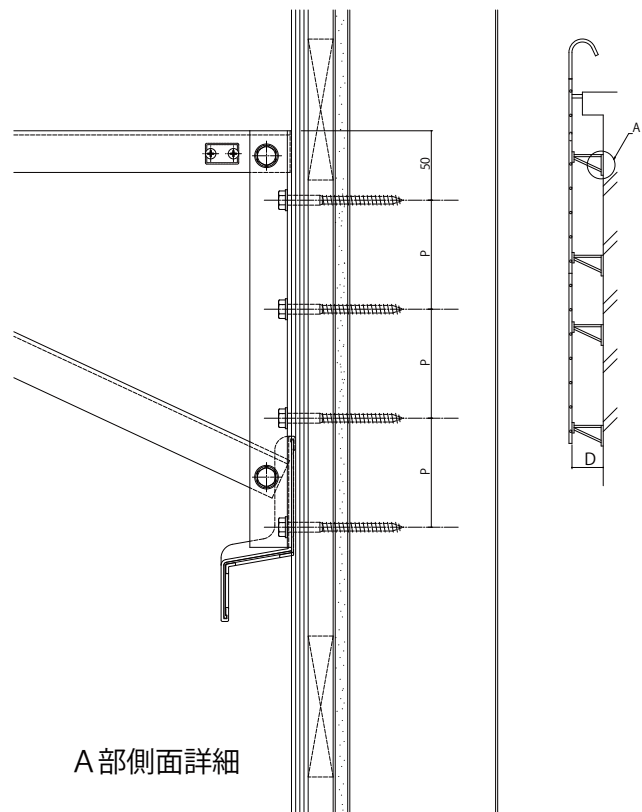

A部側面詳細