

■引違い窓 窓タイプ

●2・4枚建

内観姿図

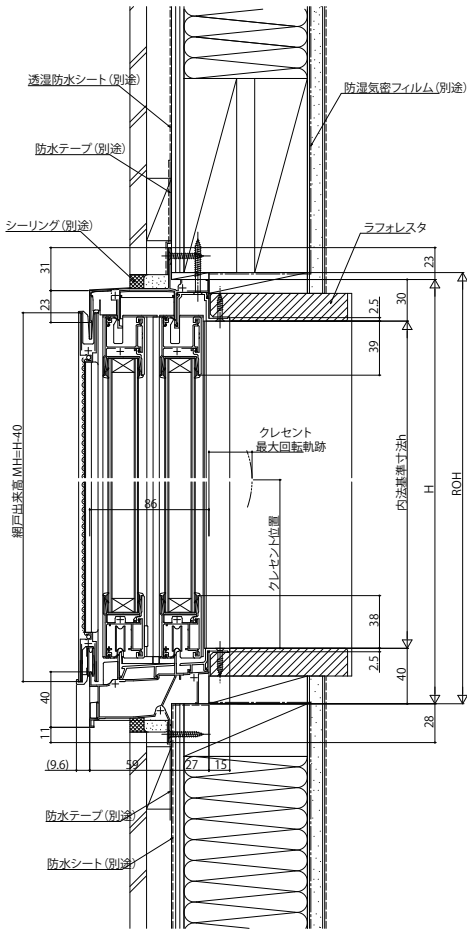
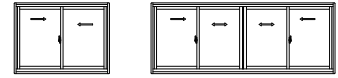

●上框
H=15,W≤1900の場合
W>1900の場合

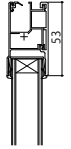

●下框
H=15,W≤1900の場合
W>1900の場合

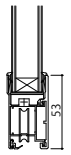

●網戸上下框 MW≥998の場合

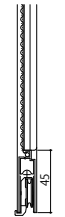

●4枚建突合せ部

網戸出来幅 MW=W/網戸出来幅 MW=W/4+14

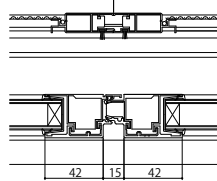

●内召合框
H=13以上,W≤1900の場合
W>1900の場合

網戸出来幅 MW=W/2-17

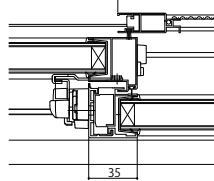

●戸先框
H=15,W≤1900の場合
W>1900の場合

